

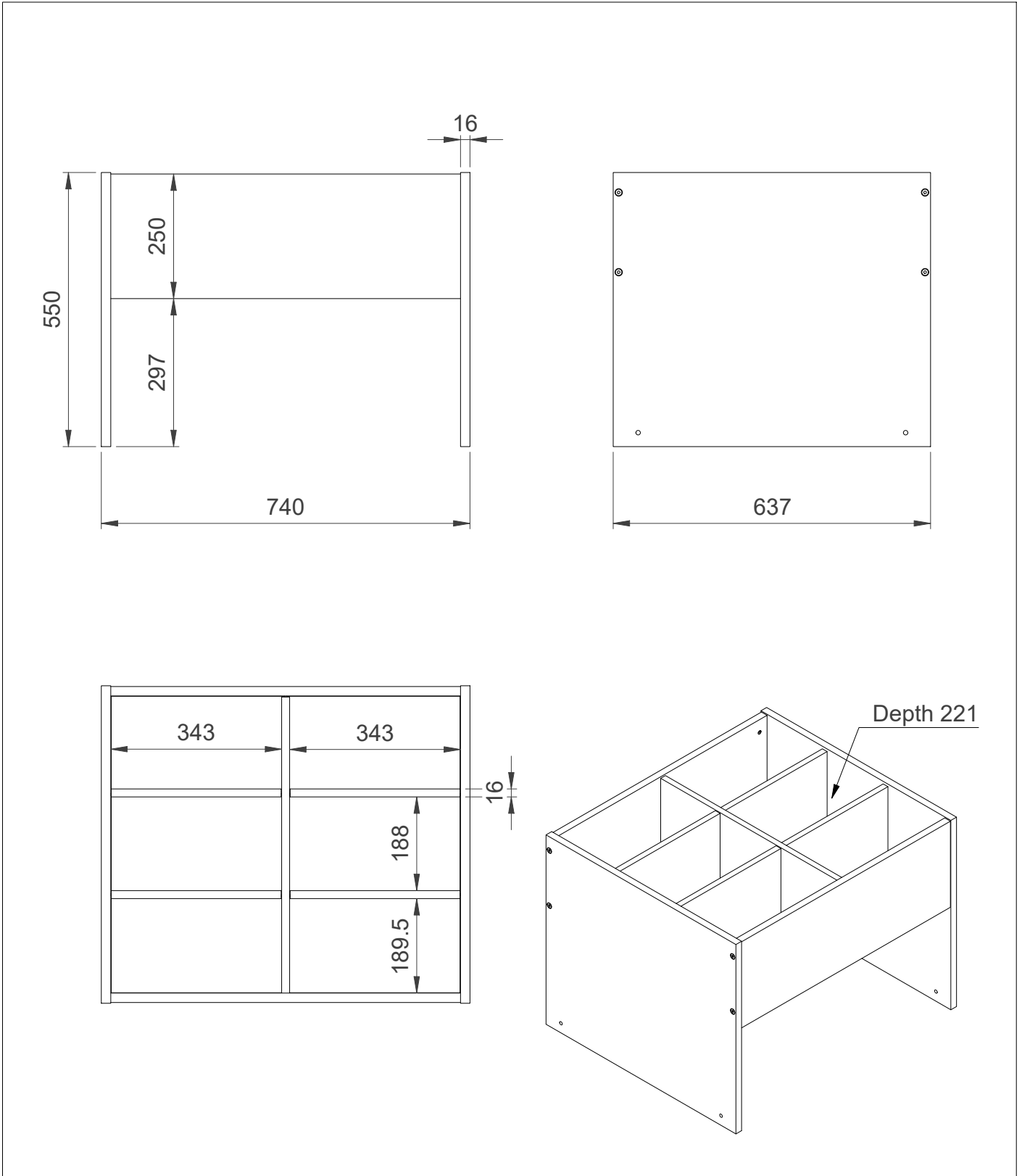



Julia Maxi Plus

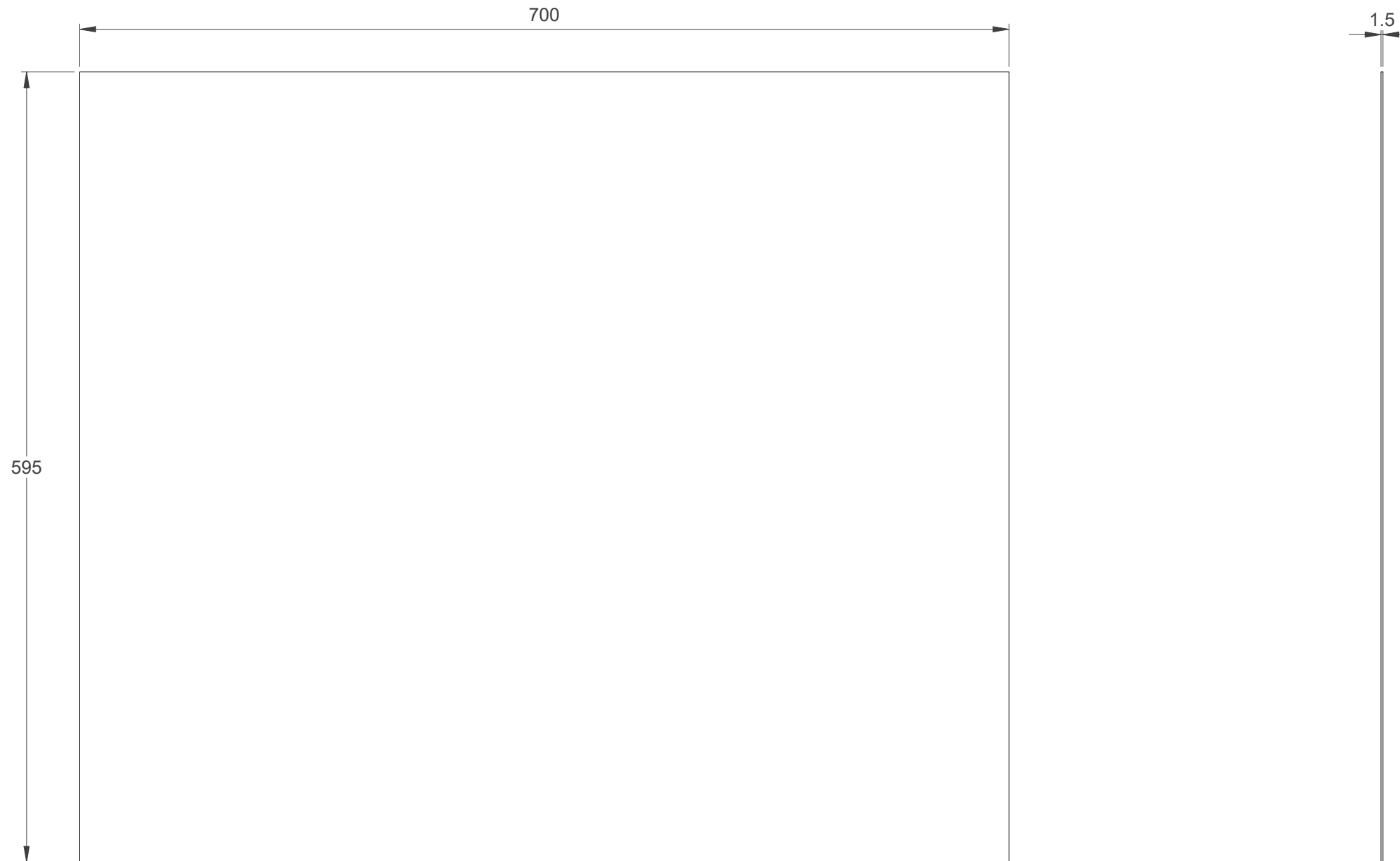

REVISION HISTORY

REV	DESCRIPTION	DATE	APPROVED
-	First release	07-02-2022	MLU

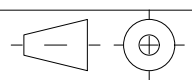

Designer MLU	Scale 1 : 4	Description Rubber mat	
Creation Date 26-01-2022	Paper Size A3	Material Rubber	
Weight 0,58 kg	Tol. ± 0,2		
	File Number 101141	Confidential: Property of BCI A/S. Not to be handed over to, copied or used by third part. Two- or three dimensional reproduction of contents to be authorized by BCI A/S.	
		Drawing Number -	

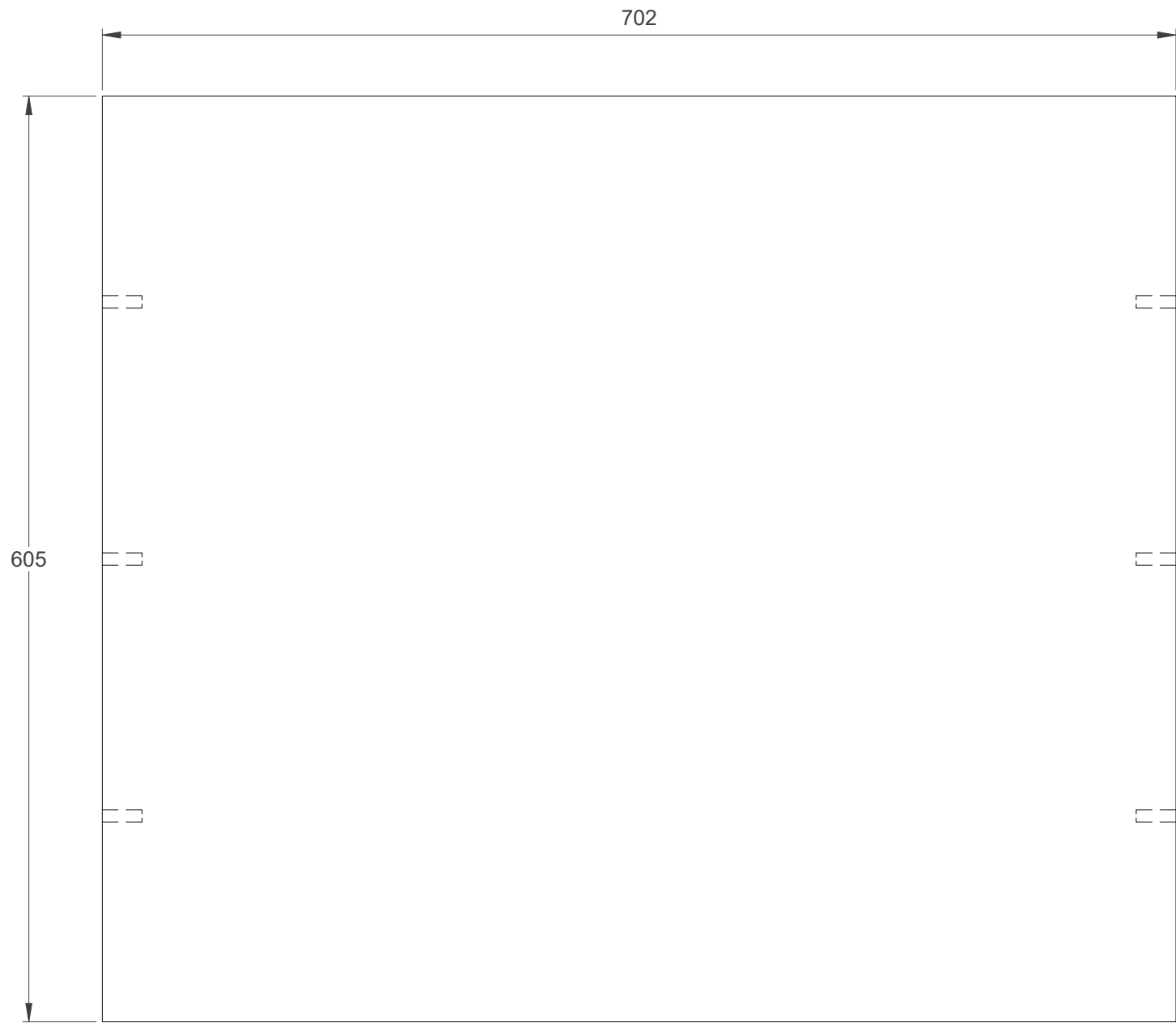

REVISION HISTORY			
REV	DESCRIPTION	DATE	APPROVED
-	First release	07-02-2022	MLU

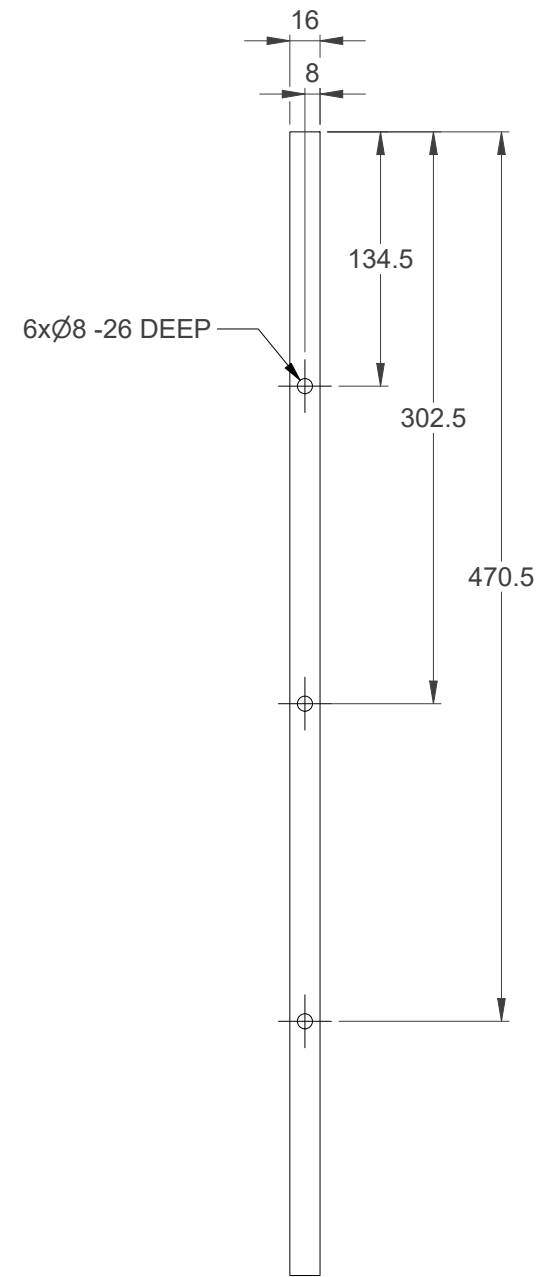



Designer MLU	Scale 1 : 4	Description Bottom plate	
Creation Date 26-01-2022	Paper Size A3	Material Chipboard	
Weight 4,48 kg	Tol. ± 0,2		
		File Number 101142	Drawing Number -
		Confidential: Property of BCI A/S. Not to be handed over to, copied or used by third part. Two- or three dimensional reproduction of contents to be authorized by BCI A/S.	

REVISION HISTORY

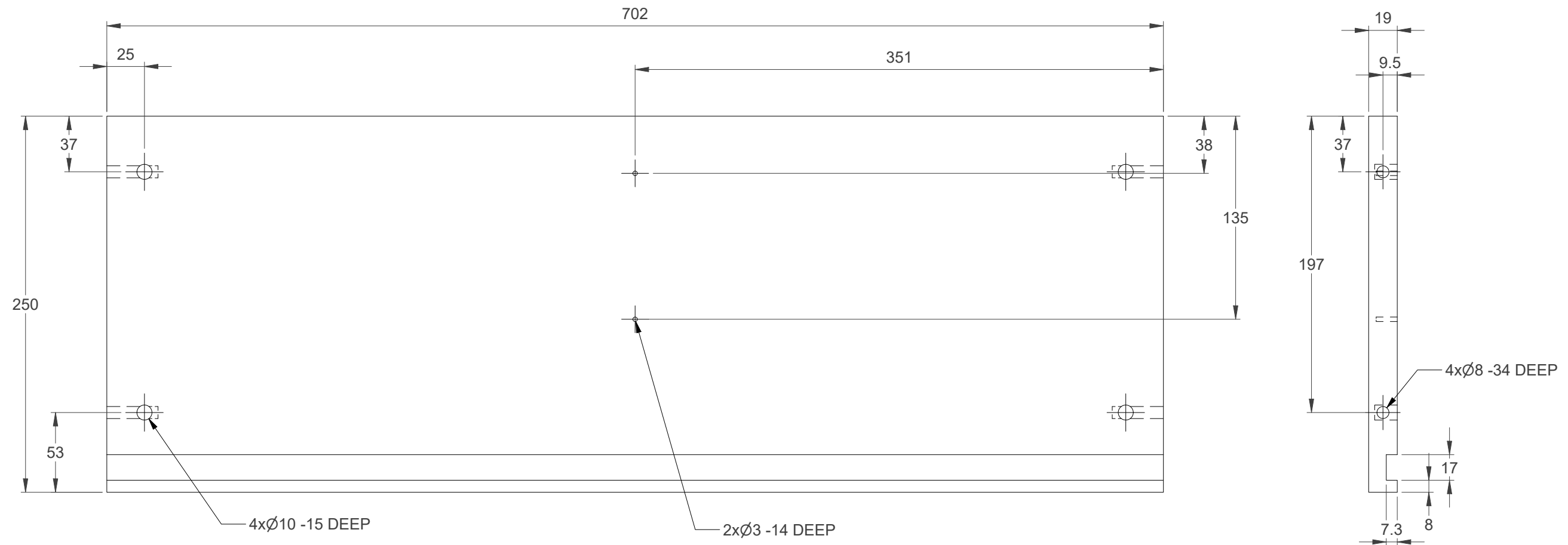
REV	DESCRIPTION	DATE	APPROVED
-	First release	09-02-2022	MLU

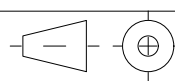

Designer MLU	Scale 1 : 3	Description Front- and backpiece	
Creation Date 26-01-2022	Paper Size A3		
Weight 2,49 kg	Tol. ± 0,2		
		Material Plywood with laminate both sides	File Number 101179
		Confidential: Property of BCI A/S. Not to be handed over to, copied or used by third part. Two- or three dimensional reproduction of contents to be authorized by BCI A/S.	Drawing Number -

REVISION HISTORY

REV	DESCRIPTION	DATE	APPROVED
-	First release	09-02-2022	MLU

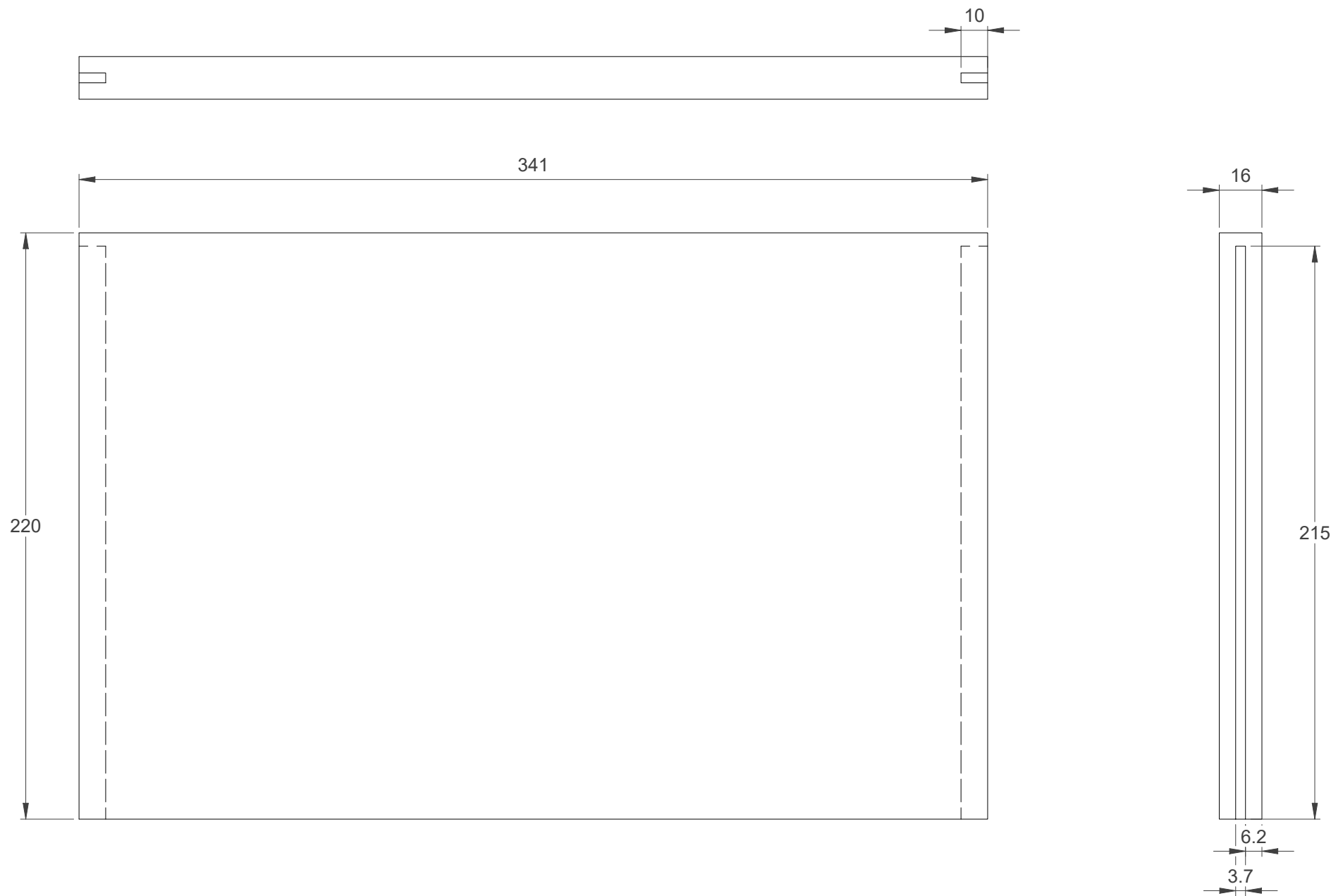



Designer MLU	Scale 1 : 2	Description Divider Short	
Creation Date 26-01-2022	Paper Size A3	Material Plywood with laminate both sides	
Weight 0,91 kg	Tol. ± 0,2		
		File Number 101180	Drawing Number -
		Confidential: Property of BCI A/S. Not to be handed over to, copied or used by third part. Two- or three dimensional reproduction of contents to be authorized by BCI A/S.	

REVISION HISTORY

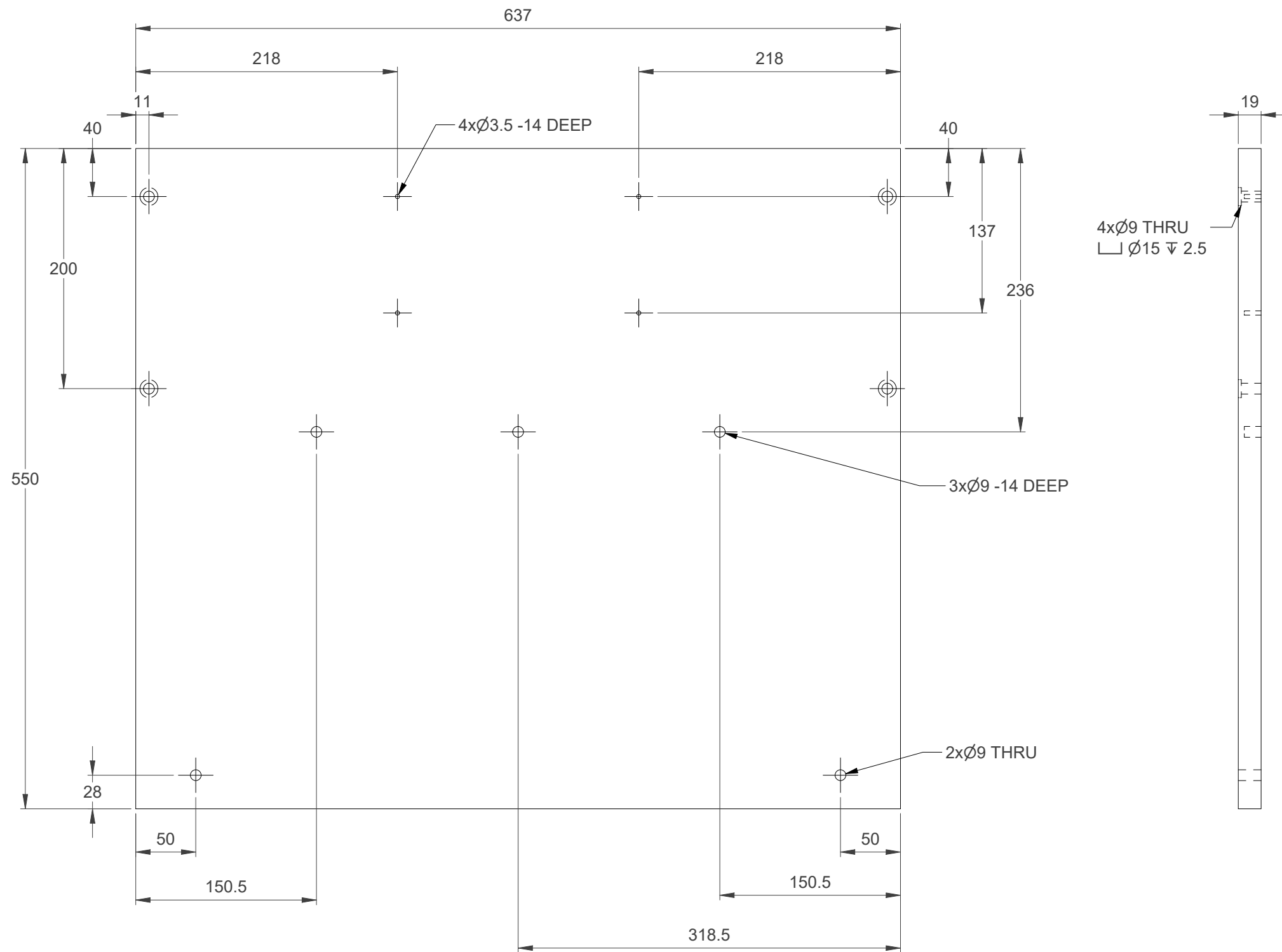
REV	DESCRIPTION	DATE	APPROVED
-	First release	09-02-2022	MLU

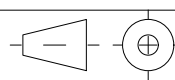



Designer MLU	Scale 1 : 4	Description End panel
Creation Date 26-01-2022	Paper Size A3	
Weight 5,12 kg	Tol. ± 0,2	
 File Number 101183		Material Plywood with laminate both sides
		Confidential: Property of BCI A/S. Not to be handed over to, copied or used by third part. Two- or three dimensional reproduction of contents to be authorized by BCI A/S. Drawing Number

REVISION HISTORY

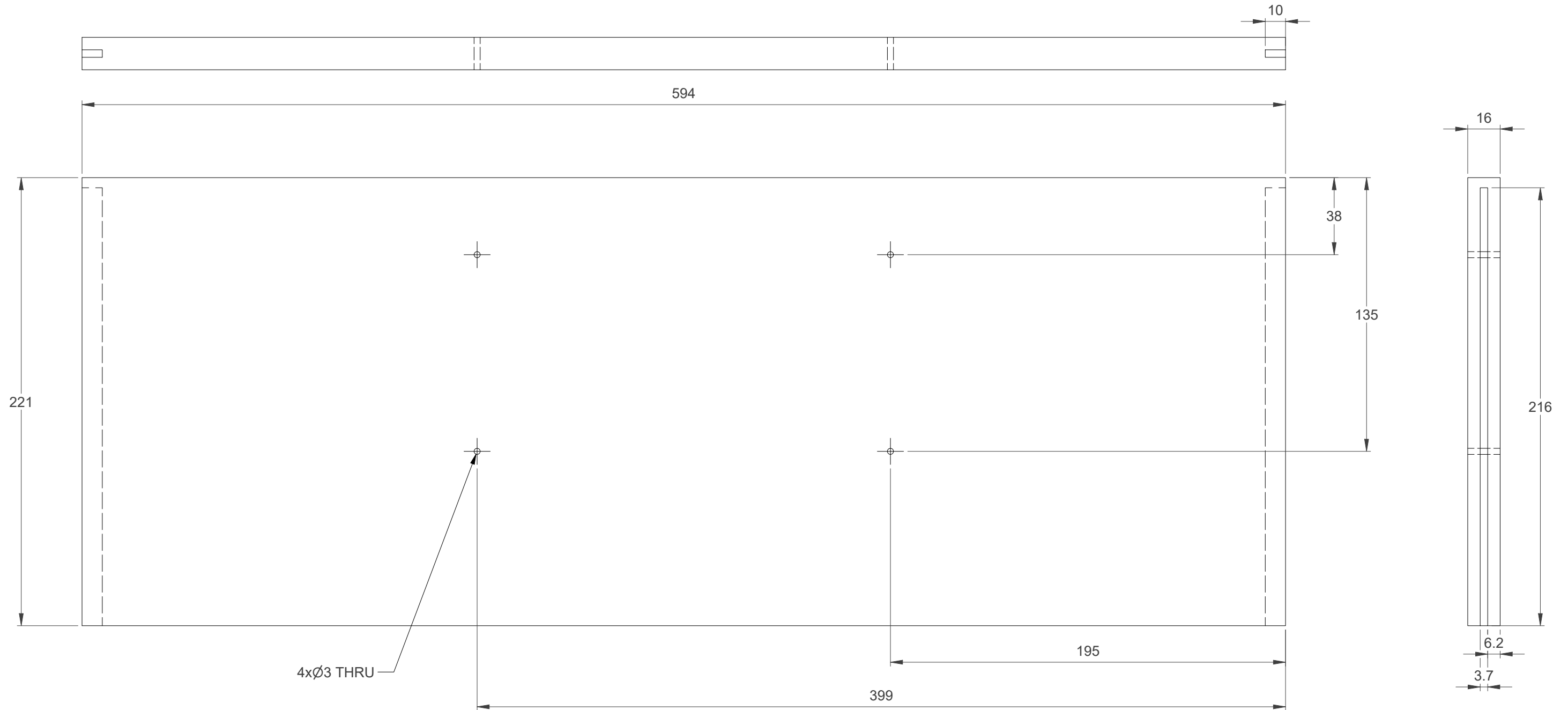
REV	DESCRIPTION	DATE	APPROVED
-	First release	09-02-2022	MLU

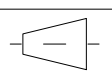
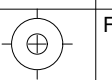

Designer MLU	Scale 1 : 2	Description Divider Long
Creation Date 26-01-2022	Paper Size A3	
Weight 1,60 kg	Tol. ± 0,2	Material Plywood with laminate both sides
 	File Number 101184	
		Confidential: Property of BCI A/S. Not to be handed over to, copied or used by third part. Two- or three dimensional reproduction of contents to be authorized by BCI A/S.
		Drawing Number -